

Standard Zubehör
Accessories





Solutions that fit your needs

alkitronic® STACO

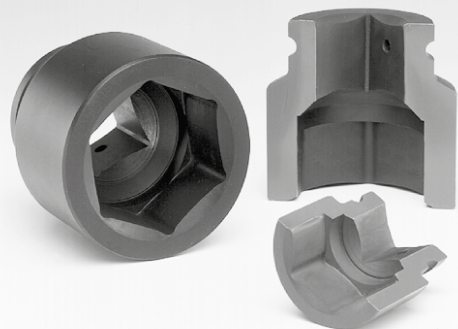
6-Kant-Standardnuss / Hex. standard sockets



		Gummiring / Rubber Ring 	Stift / Pin 
Abtriebsvierkant / Square Drive		Bestell-Nr. / Order No.	Bestell-Nr. / Order No.
Staco	3/4"	31620	31621
Staco-L	3/4"		
Staco	1"	31520	31521
Staco-L	1"		
Staco-K	1 1/2"	31420	31421
Staco-L	1 1/2"		
Staco	2 1/2"	31425	31426

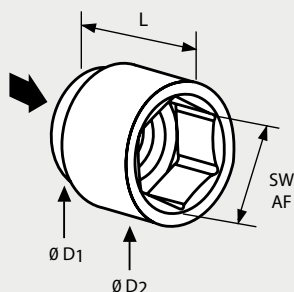

alkitronic® ➔	STACO				STACO				STACO			
	3/4"				1"				1 1/2"			
	44 mm				54 mm				85 mm			
D1	SW ¹	D ₂ ²	L	No.	SW ¹	D ₂ ²	L	No.	SW ¹	D ₂ ²	L	No.
	17	31	60	31601	19	37	82	31561	36	63	90	31471
	19	33	60	31602	22	40	82	31562	41	69	90	31472
	22	37	60	31603	24	43	82	31563	46	76	90	31473
	24	39	60	31604	27	45	82	31564	50	80	90	31474
	27	43	60	31605	30	46	82	31565	55	88	90	31475
	30	47	60	31606	32	52	82	31566	60	94	90	31476
	32	49	60	31607	36	56	82	31567				
	36	54	60	31608	41	64	82	31568				
	41	61	60	31609	46	70	82	31569				
	46	67	60	31610	50	76	82	31570				
					55	85	82	31512				
					60	87	82	31513				
					65	92	82	31514				

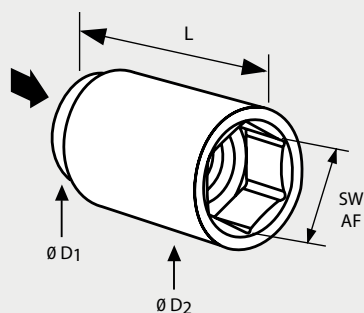

alkitronic® ➔	STACO-L				STACO-L				STACO-L			
	3/4"				1"				1 1/2"			
	44 mm				54 mm				85 mm			
D1	SW ¹	D ₂ ²	L	No.	SW ¹	D ₂ ²	L	No.	SW ¹	D ₂ ²	L	No.
	17	31	100	31631	22	40	110	31531	36	63	110	31451
	19	33	100	31632	24	43	110	31532	41	69	110	31452
	22	37	100	31633	27	45	110	31533	46	76	110	31453
	24	39	100	31634	30	46	110	31534	50	80	110	31454
	27	43	100	31635	32	52	110	31535	55	88	110	31455
	30	47	100	31636	36	56	110	31536	60	94	110	31456
	32	49	100	31637	41	64	110	31537	65	99	110	31457
	36	54	100	31638	46	70	110	31538	70	107	110	31408
	41	61	100	31639	50	76	110	31539	75	113	110	31409
	46	67	100	31640	55	85	110	31540	80	119	116	31410
					60	87	110	31541	85	125	121	31411
					65	92	110	31542	90	132	127	31412
									95	138	127	31413

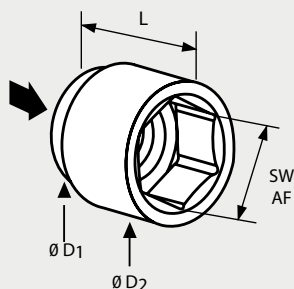

alkitronic® ➔	STACO				STACO			
	2 1/2"				2 1/2"			
	127 mm				140 mm			
D1	SW ¹	D ₂ ²	L	No.	SW ¹	D ₂ ²	L	No.
	65	106	138	31921	120	175	175	31932
	70	113	140	31922	125	181	175	31933
	75	119	143	31923	130	188	180	31934
	80	125	150	31924	135	194	180	31935
	85	132	155	31925	140	200	185	31936
	90	138	160	31926	145	206	185	31937
	95	144	160	31927	150	213	190	31938
	100	150	165	31928	155	219	200	31939
	105	156	165	31929	160	225	205	31940
	110	163	170	31930	165	231	205	31941
	115	169	175	31931	170	238	210	31942

1) SW in mm / AF in mm; 2) ungefähre Maße in mm; approximate dimensions in mm

alkitronic® STABI

Standardverbinder / Standard connector



Stift/Pin

Gummiring/
Rubber ring



Standard Verbinder/connector -H/-S

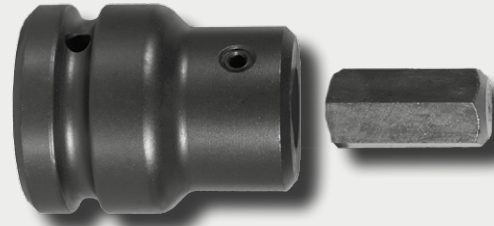

Baugruppe / Assembly

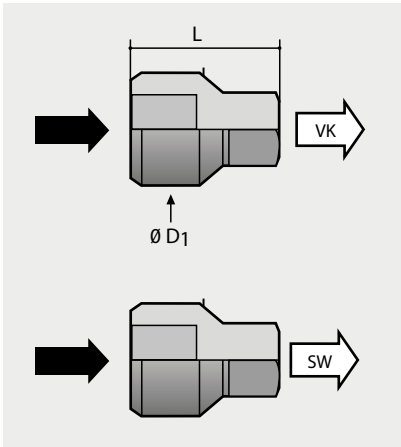

alkitronic® ➔	STABI 3/4"		STABI 1"		STABI 1 1/2"		STABI 2 1/2"	
	D1	L	D1	L	D1	L	D1	L
	50 mm	75 mm	60 mm	75 mm	78 mm	105 mm	127 mm	156 mm
	VK □	No.	VK □	No.	VK □	No.	VK □	No.
	1/2"	31305	3/4"	31205	1"	31105	1 1/2"	31101
	1"	31307	1 1/2"	31207	2 1/2"	31107		
	SW ¹ ○	No.	SW ¹ ○	No.	SW ¹ ○	No.		
	17	31312	24	31213	24	31112		
	19	31313	27	31214	27	31113		
	22	31314	30	31215	30	31114		
	24	31315	32	31216	32	31115		
					36	31116		

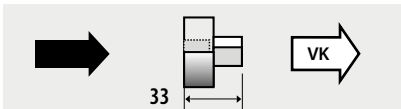

Verbinder / Connector* in	out	Bestell-Nr. / Order No.
➔ 1/2"	VK □ 3/4"	31357-K

* nur für Modell alkitronic® M-HG / only for model alkitronic® M-HG

alkitronic® STABI-HALTER/STABI-STIFT Standardverbinder-H/-S / Standard connector-H/-S (Baugruppe / Assembly)

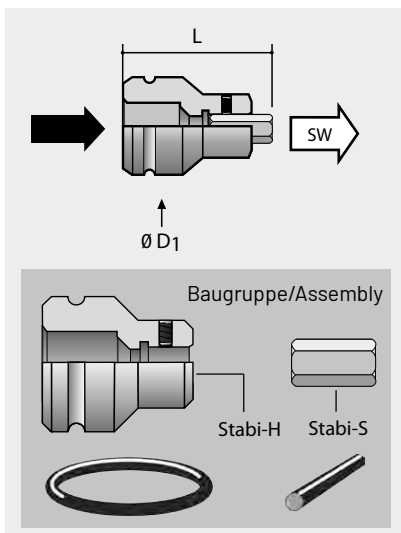

alkitronic® ➔	STABI-H / STABI-S			STABI-H / STABI-S			STABI-H / STABI-S		
	Gummiring / Rubber Ring Stift / Pin			Gummiring / Rubber Ring Stift / Pin			Gummiring / Rubber Ring Stift / Pin		
	3/4"			1"			1 1/2"		
	Ø D1			54 mm			85 mm		
	SW ¹	L	BG. No.**	SW ¹	L	BG. No.**	SW ¹	L	BG. No.**
	12	76	31001	17	85	31008	19	105	31015
	14	76	31002	19	85	31009	22	105	31016
	17	76	31003	22	85	31010	24	105	31017
	19	76	31004	24	87	31011	27	105	31018
	22	76	31005	27	87	31012	30	105	31019
	24	76	31006	30	87	31013	32	105	31020
				32	89	31014	36	108	31021
							41	120	31022
							46	122	31023

** BG (Baugruppe/Assembly)

alkitronic® STA

Standardadapter / Standard adaptor

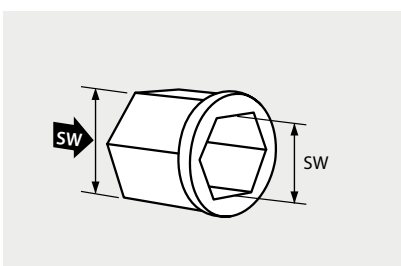

alkitronic® ➔	STA 36 mm		STA 46 mm		STA 55 mm		STA 65 mm		STA 70 mm		STA 80 mm		STA 105 mm	
	SW ¹	No.	SW ¹	No.	SW ¹	No.	SW ¹	No.	SW ¹	No.	SW ¹	No.	SW ¹	No.
	24	31705	36	31701	36	31711	36	31721	36	31731	46	31741	80	31861
	27	31706	41	31702	41	31712	41	31722	41	31732	50	31742	85	31863
	30	31707			46	31713	46	31723	46	31733	55	31743	95	31862
	32	31708					50	31724	50	31734	60	31744		
							55	31725	55	31735	65	31745		
							60	31736	70	31746				

1) SW in mm / AF in mm; 2) ungefähre Maße in mm; approximate dimensions in mm

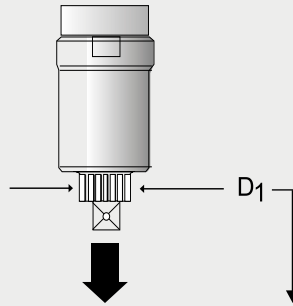
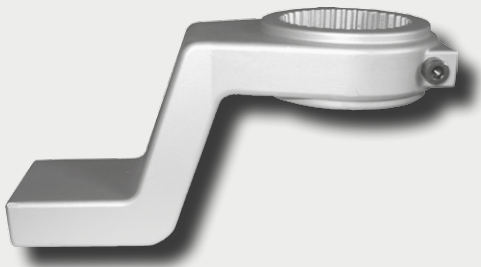

Bestell-Nr. / Order No.
▼

Abstützfuß / Reaction foot

DMA 10231
DMA 10232

Sicherungsschraube (optional)
Security bolt (optional)

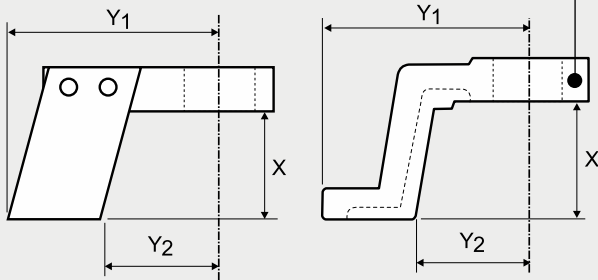

Abtriebsvierkant Square drive	mm				DMA No.
	D1	X	Y1	Y2	
3/4"	41	74	75	51	10231
3/4"	41	128	75	51	10232
3/4"	41	65	120	70	10251
3/4"	54	83	130	85	10252
1" (*)	54	83	150	85	10253
1", 1 1/2"	72	85	194	110	10234
1 1/2"	72	123	220	120	10256
1 1/2"	91	123	220	120	10257

Gegenhalter / Toward support

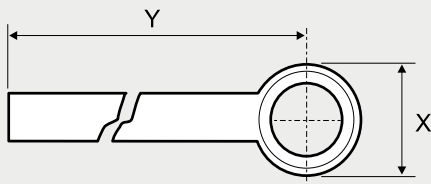

	D1	X	Y	DMA No.
3/4"	41	65	210	10261
1"	54	80	240	10262
1 1/2"	72	105	240	10265
1 1/2"	91	105	240	10267

Abstützring / Reaction ring

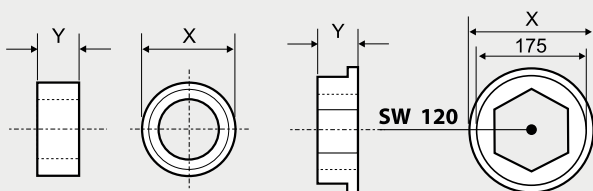

	D1	X	Y	DMA No.
3/4"	41	65	28	10246
1"	54	80	28	10247
1 1/2"	72	110	33	10248
1 1/2"	72	110	47	10249
1 1/2"	91	130	52	10250
2 1/2"	SW 120	180	57	10416

Sicherungsring / Security ring

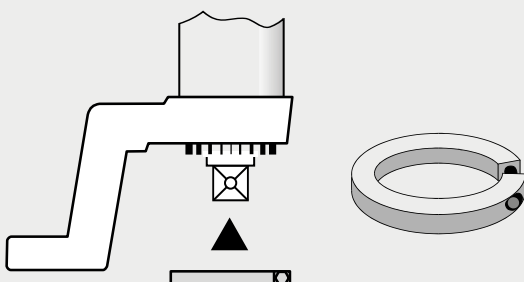

	D1	DMAR No.
	41	10271
	54	10272
	72	10275
	91	10277

(* Für Drehmomente über 2000 Nm empfehlen wir: DMA 10253 /
For torques higher than 2000 Nm we recommend you use: DMA 10253

(** DMA 10254 (Aluminium-Legierung) für Drehmomente < 3500 Nm /
DMA 10254 (Aluminium alloy) for torques < 3500 Nm

alkitronic® Drehmomentschlüssel / Torque wrench



Drehmomentschlüssel

mit automatisch auslösendem akustischem Signal, eingebauter Knarre mit kleinem Nachholwinkel und einfacher sicherer Einstellung des Drehmomentwertes. Bei Verwendung als Antriebselement für unsere **alkitronic® M** - Handkraftschrauber, werden Drehmomente bis 50.000 Nm sicher und schnell beherrscht.

Torque wrench

makes an audible click when preset torque load is reached. Equipped with a ratchet. Easy and accurate torque setting. Suitable for use with our **alkitronic® M** - multiplier driver; torque output up to 50,000 Nm; robust and quick operation.

Abtriebsvierkant Square Drive	Messbereich Span	Teilstrich- skala Scale	Länge Length	Gewicht Weight	Bestell-Nr. Order No.
	Nm	Nm	mm	kg	
3/4"	40-280		691	1,900	31352
3/4"	60-420		965	3,300	31353
3/4"	100-700		1314	6,200	31354
1"	100-1000		1538	9,800	31361

Auszug Sonderzubehör / Some special accessories

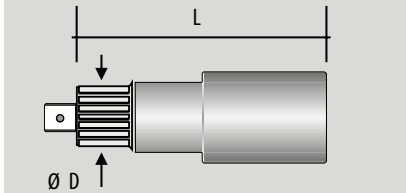

ATV - Abtriebsverlängerung / Square drive extension

Abtriebsverlängerung Square drive extension	Ø D	Länge Length	Bestell-Nr. Order No.
ATV	mm	L (mm/in)	
3/4"	41	254 / 10"	10286
1"	54	229 / 9"	10278
1"	54	305 / 12"	10279



Aufhänger mit Öse u. Griff / Hanging device with handle and eyebolt

Aufhänger/Hanging device (Ø in mm)	85	88	93	98	109	132
Bestell-Nr. / Order No.	10124	10125	10126	10123	10122	10120

IHR PLUS FÜR MEHR LEISTUNG YOUR PLUS FOR MORE PERFORMANCE

Höhere Qualität

Erstklassige Produktion
Einsatz hochwertiger Materialien
Lange Produktlebensdauer
Seit 1984 Erfahrung in der Schraubtechnik
Made in Germany – weltweite Patente

Increased quality

Premium production
Highest quality materials
Long product life cycles
Since 1984 experience in bolting technology
Made in Germany – international patents

Höhere Produktivität

Schnelles Verschrauben ohne Nacharbeiten
Kein umweltbedingter Ausfall (IP 54, ATEX)
Hohe Arbeitssicherheit
Einfache Bedienung – kurze Einarbeitung
Wartungsarm und kosteneffizient

Increased productivity

Quicker tightening without reworking
No environmentally caused failures (IP54, ATEX)
High work safety
Easy to use: clear, simple instructions
Low maintenance and cost efficient

Höhere Präzision

Exakte, kundenspezifische Drehmomente
Hohe Wiederholgenauigkeit
Zuverlässigkeit bei Dauerbelastung
Schraubfall Dokumentation
Abschaltautomatik

Increased precision

Precise, customer-specific torques
High repeatability
Reliability in permanent operation
Documentation of tightening results
Automatic shut-off

Besserer Service

Technische Beratung vor Ort
Schulungs- und Trainingsangebote
Werkskalibrierung und -zertifizierung
Lifecycle Betreuung
Ersatzteil- und Reparaturservice

Better service

Technical advice on site
Training offers
Manufacturer's calibration and certification
Lifecycle support
Spare part and repair service

alki TECHNIK GmbH

Entwicklung, Produktion und Vertrieb von Schraubsystemen
Development, Production and Distribution of Bolting Systems

Unterlettenweg 4 – 85051 Ingolstadt/Germany – fon +49 841 97499-0 – fax +49 841 97499-90
info@alkitronic.com – www.alkitronic.com

AUSZUG AUS UNSEREM PRODUKTPROGRAMM EXTRACT FROM OUR PRODUCT RANGE



alkitronic® X-E-SERIES

THE ELECTRICS



alkitronic® X-P-SERIES

THE PNEUMATICS



alkitronic® X-H-SERIES

THE HYDRAULICS



alkitronic® X-M-SERIES

THE MANUALS